

GAMA
PEYZAJ İNŞAAT
MİMARLIK VE MÜHENDİSLİK
TİCARET LİMİTED ŞİRKETİ



Siz hayal edin biz üretelim

You imagine
We produce



www.gamainsaat.com

HAKKIMIZDA

Firmamız; çocuk oyun grupları, oyun elemanları, açık hava spor aletleri, gazebo, pergole, bank, çöp kovası ve geri kazanım üniteleri gibi şehircilikte ve peyzaj sektöründe kullanılan birçok kent mobilyalarını proje, tasarım ve üretimini kendi bünyesinde çözen bir firmadır. Üretimin dışında, teknik ekip ve kadrosu ile çevre düzenleme-peyzaj tasarım projeleri hazırlayan, yapısal-bitkisel peyzaj uygulamaları yapan sektörde öncü firmalardandır.

Dijital teknolojilerin hızla gelişmesi sebebiyle, asosyalleşen ve daha az hareket eden bir dünya ortaya çıkmaktadır. Hızla artan nüfusun yeşil alanları azalttığını görmekteyiz. Herkesin sosyalleşmesine katkı sağlayacağı bilinci ile tasarım, üretim ve uygulamalar yaparak, yapmış olduğumuz işin önemli ve sorumluluk gerektiren bir iş olduğunun farkındayız.

Firma olarak tüm yaşam alanlarımızı daha yaşanabilir hale getirmeye ve güzelleştirmeye kararlıyız. Sizlerin çözüm ortağı olmaktan mutluluk duyarız.

ABOUT US

Our company is a firm that handles the project, design, and production of various urban furniture used in urban planning and landscaping, such as children's playgroups, play elements, outdoor sports equipment, gazebos, pergolas, benches, trash bins, and recycling units. In addition to production, we are among the leading companies in the industry in creating environmental design and landscaping projects with our technical team and staff, as well as implementing structural and botanical landscaping applications.

Due to the rapid development of digital technologies, a world that is becoming more antisocial and less active is emerging. We see that the rapidly increasing population is reducing green spaces. With the awareness that our work can contribute to everyone's socialization, we are conscious that the design, production, and applications we carry out are important and carry responsibilities.

As a company, we are committed to making all living spaces more livable and beautiful. We would be delighted to be your solution partner.



EF-101



EF-102



EF-103



EF-104



EF-105



EF-106



EF-107



EF-108



EF-109



ORMAN SERİSİ OYUN GRUBU

FOREST SERIES PLAY SYSTEMS

EF-201



EF-202



EF-203



EF-204



TREN SERİSİ OYUN GRUBU

TRAIN SERIES PLAY SYSTEMS

EF-251



EF-252



EF-253



EF-254



SHIP SERIES PLAY SYSTEMS

GEMİ SERİSİ OYUN GRUBU

EF-301



EF-302



EF-303



EF-304



CASTLE SERIES PLAY SYSTEMS

KALE SERİSİ OYUN GRUBU

EF-351



EF-352



EF-353



EF-354



AHŞAP SERİSİ OYUN GRUBU

WOODEN SERIES PLAY SYSTEMS

EF-401



EF-402



EF-403



EF-404



EF-405



ENGELSİZ SERİSİ OYUN GRUBU

INCLUSIVE SERIES PLAY SYSTEMS

EF-451



EF-452



EF-453



EF-454



EF-501

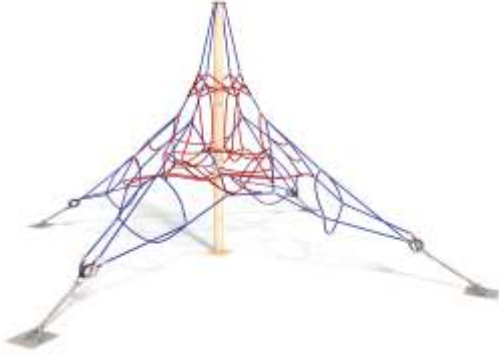

EF-502

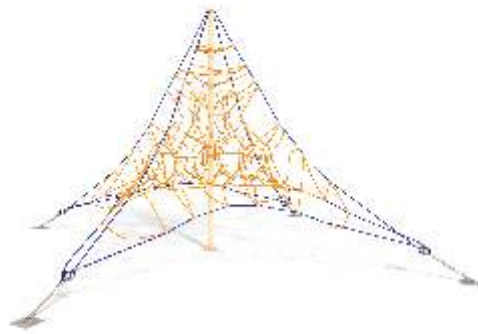

EF-503

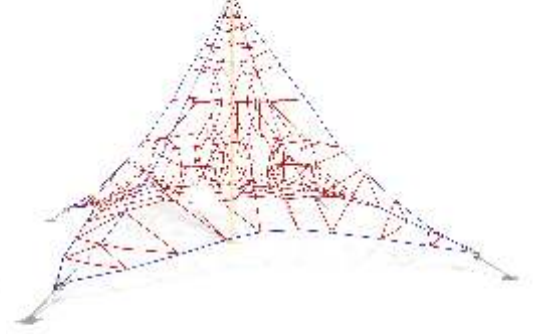

EF-504



EF-505

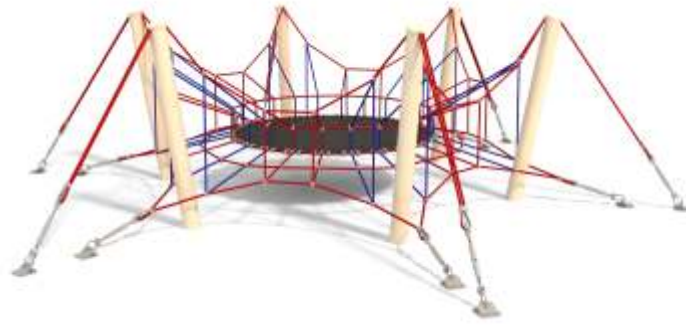

EF-506



EF-507



ROBOT SERİSİ OYUN GRUBU

ROBOT SERIES PLAY SYSTEMS

EF-151



EF-152



EF-153



EF-154



TELEFELİK SERİSİ OYUN GRUBU

CABLEWAY SERIES PLAY SYSTEMS

EF-141



EF-142



EF-131



EF-132



EF-133



EF-134



OYUN ELEMANLARI

PLAY EQUIPMENTS

EF-551



EF-552



EF-553



EF-554



EF-555



EF-557



EF-558



EF-559

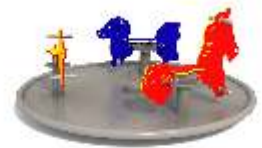

EF-560



EF-561



EF-562



EF-563



EF-564



EF-565

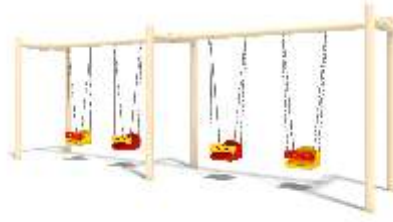

EF-566



EF-567



EF-568



EF-569



EF-570



EF-571



EF-572



EF-573



EF-574



EF-575



FITNESS SERİLERİ

FITNESS SERIES

EF-601



EF-602



EF-603



EF-604



EF-605



EF-606



EF-607



EF-608



EF-609



EF-610



EF-611



EF-612



EF-613



EF-614



EF-615

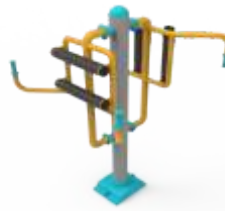

EF-616



EF-617



EF-618



EF-619



EF-651



EF-652



EF-653



EF-654



EF-655



EF-656



EF-657



EF-658

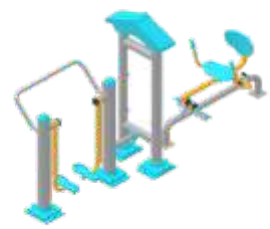

EF-659



EF-660



EF-661



EF-662



EF-701



EF-702



EF-703



EF-704



EF-705



EF-711



EF-721



ENGELSİZ FITNESS SERİSİ

INCLUSIVE FITNESS SERIES

EF-751



EF-752



EF-753



EF-754



EF-755



EF-801



EF-802



EF-803



EF-804



EF-805



BİSİKLET PARKLARI

BICYCLE PARKS

EF-811



EF-812



EF-813



EF-814



EF-815



AĞAÇ ALTI IZGARALAR

TREE GRID

EF-821



EF-822



EF-823



EF-824



EF-825



BENCHES

BANKLAR

EF-846



EF-847



EF-848



EF-849



EF-850



EF-851



EF-852



EF-853



EF-854



EF-855



EF-856



EF-857



EF-858



EF-859



EF-860



EF-861



EF-862



EF-863



BANKLAR

BENCHES

EF-864



EF-865



EF-866

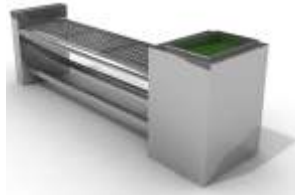

EF-867



EF-868



EF-869



EF-872

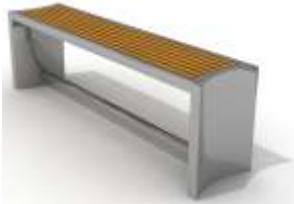

EF-873



EF-874



EF-875



EF-876



EF-877



LITTER BINS

ÇÖP KOVALARI

EF-901



EF-902



EF-903



EF-904



EF-905



EF-906



EF-907



EF-908



EF-909



EF-910



EF-911



EF-912



EF-913



EF-914



EF-915



EF-916



EF-917



EF-918



EF-919



ÇÖP KOVALARI

LITTER BINS

EF-920



EF-921



EF-922



EF-923



EF-924



EF-925



EF-926



EF-927



EF-928



EF-929



EF-930



EF-931



EF-932



EF-933



EF-934



EF-935



FLOWER POTS

SAKSILAR

EF-936



EF-937



EF-938



EF-939



EF-940



EF-941



EF-942



EF-943

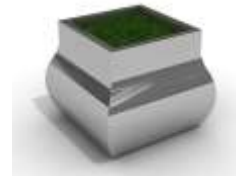

EF-944



EF-945



EF-946



EF-947



GERİ DÖNÜŞÜM KUTULARI

RECYCLING BINS

EF-951



EF-952



EF-953



EF-954



EF-955



EF-956



EF-957



EF-958



EF-959



EF-960



EF-961



EF-962



EF-963



EF-964



EF-965



EF-966



EF-967



EF-968



RECYCLING BINS

GERİ DÖNÜŞÜM KUTULARI

EF-969



EF-970



EF-971



EF-972



EF-973



EF-974



EF-975



EF-976



EF-977



EF-978



EF-979



EF-980



EF-981



EF-982



EF-983



EF-984



EF-985



EF-986



GERİ DÖNÜŞÜM KUTULARI

RECYCLING BINS

EF-987



EF-988



EF-989



EF-990



EF-991



EF-992



EF-993



EF-994



EF-995



EF-996



EF-997



EF-998



EF-999



EF-1000



EF-1001



EF-1002



EF-1003



EF-1004



ROOFED PICNIC TABLES AND GAZEBOS

ÇATILI PİKNIK MASALARI VE GAZEBOLAR

EF-1051



EF-1052



EF-1053



EF-1054



EF-1055



EF-1056



EF-1057



EF-1058



EF-1059



EF-1060



EF-1061



EF-1062



EF-1063



EF-1064



EF-1065



EF-1066



PİKNİK MASALARI

PICNIC TABLES

EF-1101



EF-1102



EF-1103



EF-1104



EF-1105



EF-1106



EF-1107



EF-1108



EF-1109



EF-1110



EF-1201



EF-1202



EF-1203



EF-1204



EF-1205



EF-101

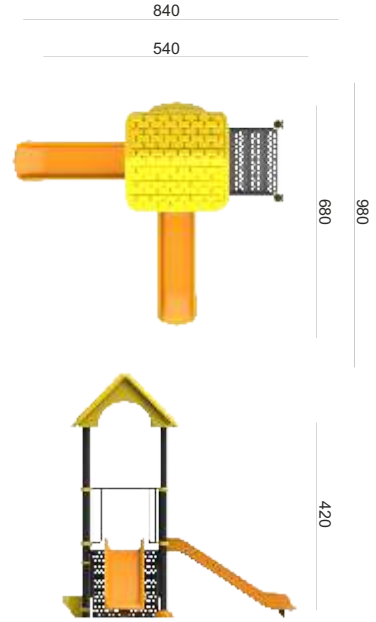

EF-102

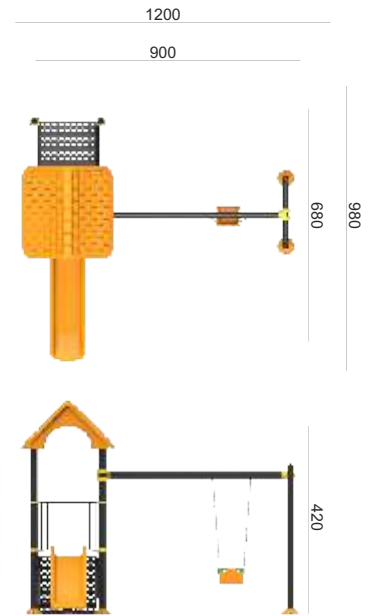

EF-103

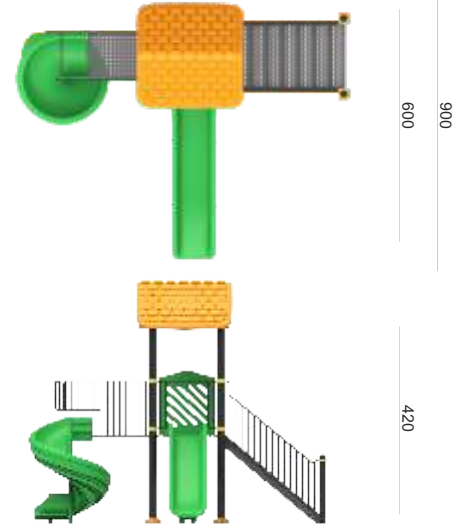

EF-104

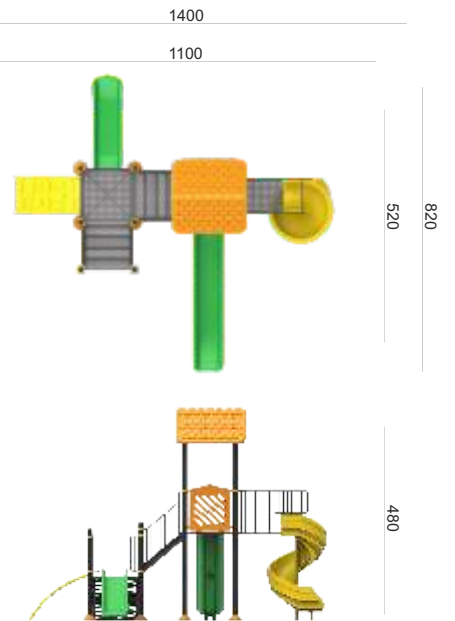

EF-105

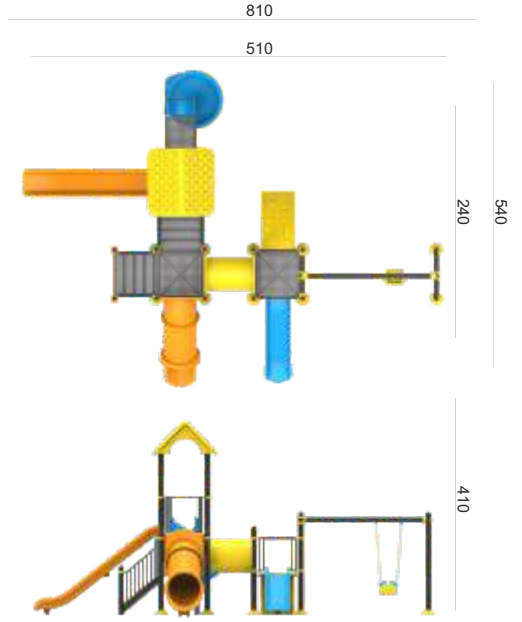

EF-106



ECONOMIC SERI PLAY SYSTEMS

EKONOMİK SERİ OYUN GRUBU

EF-107

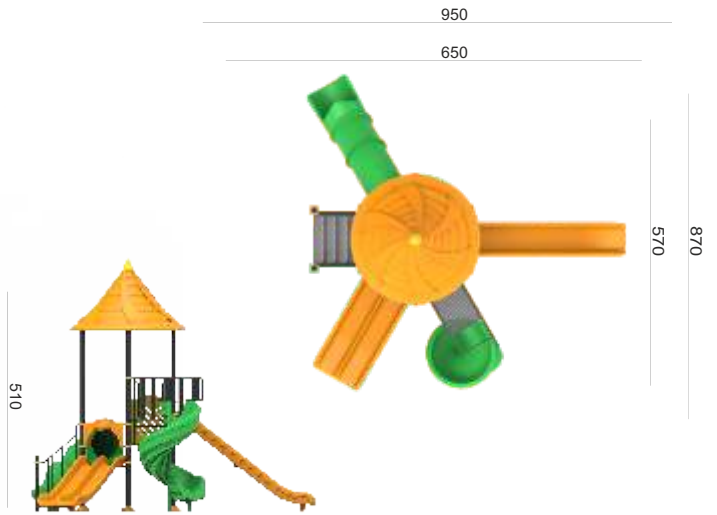

EF-108

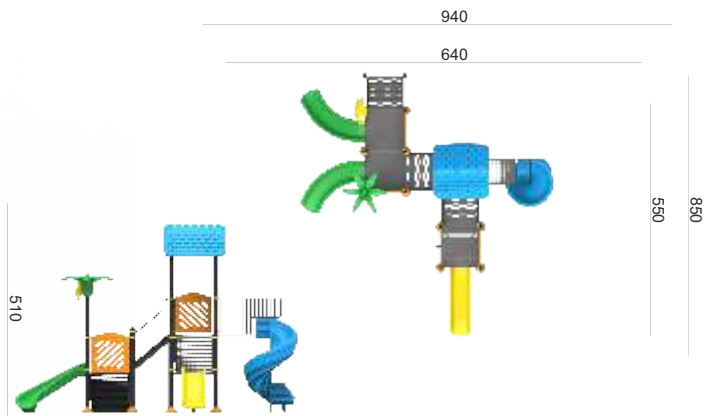

EF-109

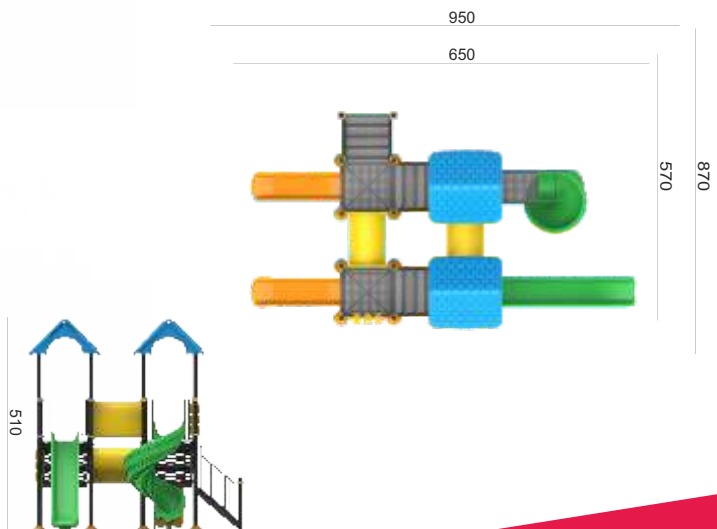

EF-201



880
580



720
420



360

EF-202



1200
900



880
560



460



EF-203



EF-204



EF-251



890

590



290

590



330

EF-252



1320

1020

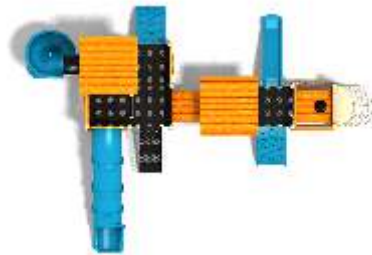

690

980



410



TRAIN SERIES PLAY SYSTEMS

TREN SERİSİ OYUN GRUBU

EF-253



1380

1080

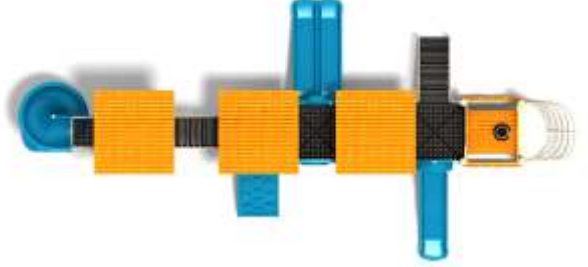

520

820



410

EF-254



920

620

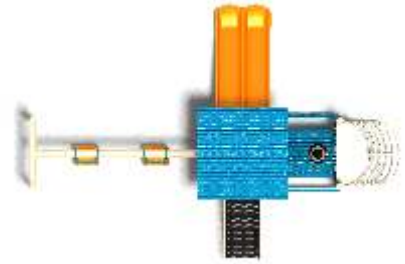

450

750



330



EF-301



1040

740

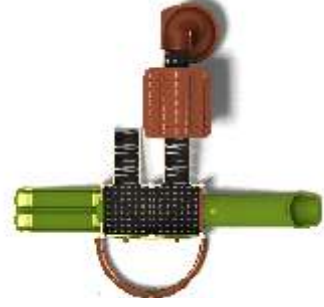

720

1020



450

EF-302



1260

960

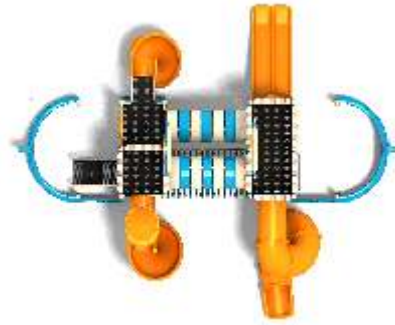

670

970



580



EF-303



1340

1040

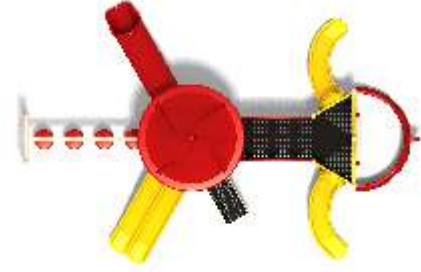

600

900



480

EF-304



1280

980

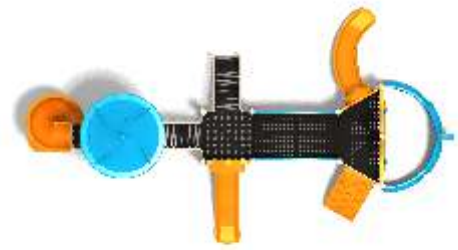

600

900



490



EF-351



EF-352

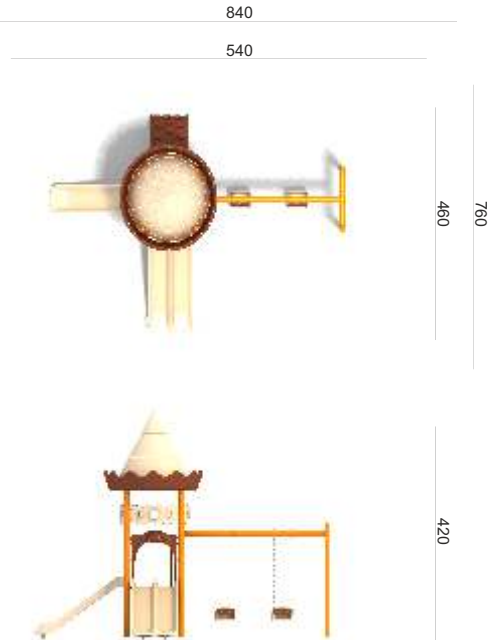

EF-353



1380

1080



700

1000



500

EF-354



1580

1280



1140

1440



580



EF-401

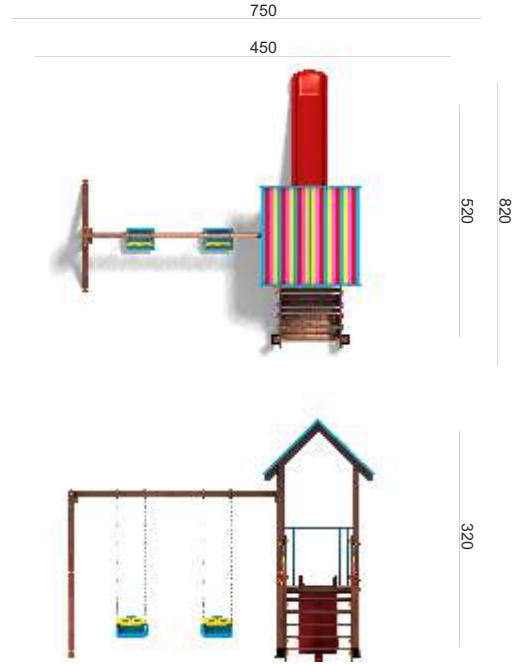

EF-402

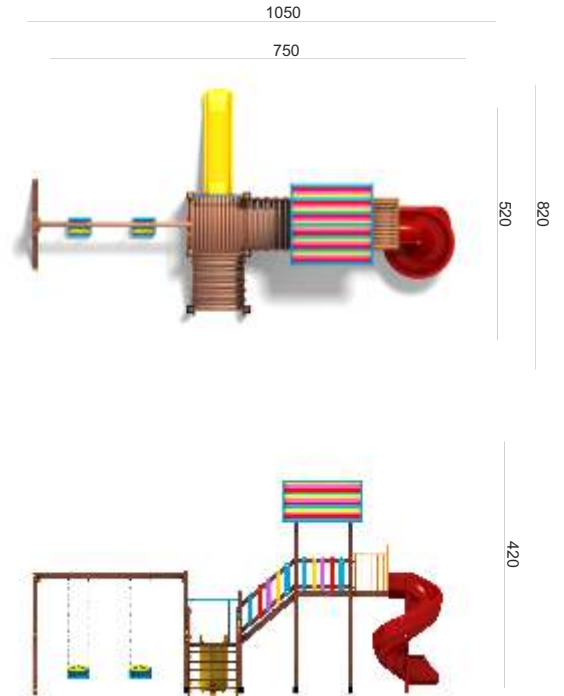

EF-403

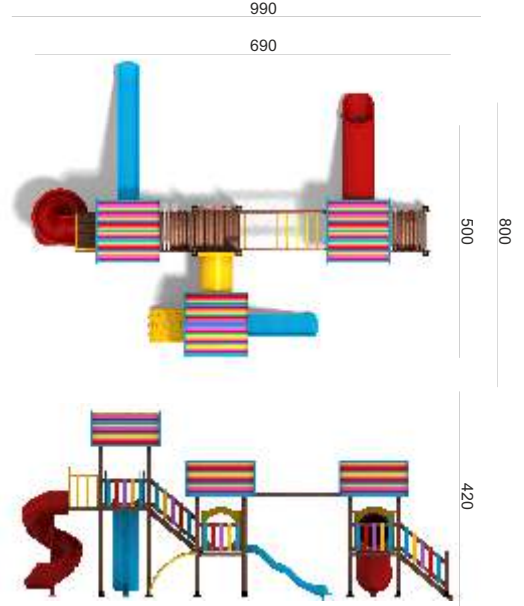

EF-404

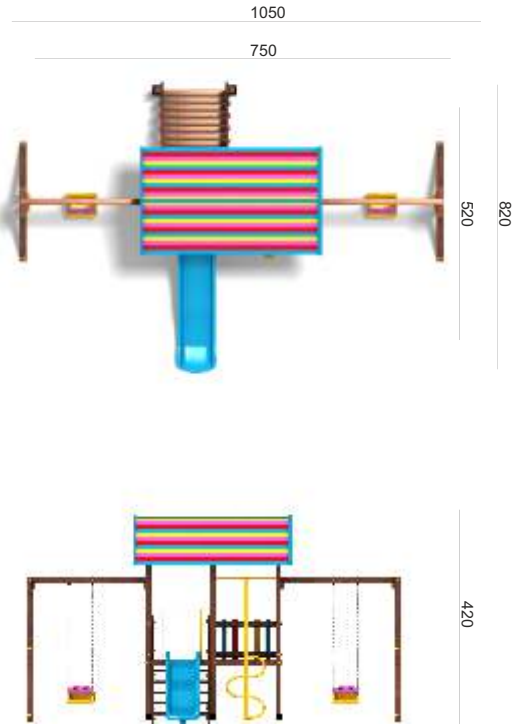

EF-405



INCLUSIVE SERIES PLAY SYSTEMS

ENGELSİZ SERİSİ OYUN GRUBU

EF-451

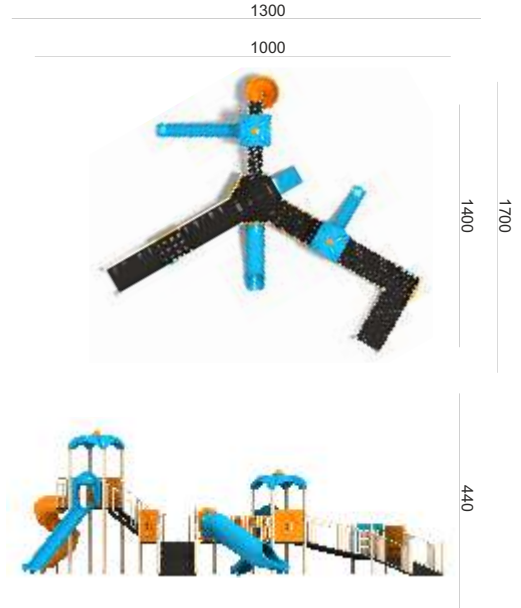

EF-452



ENGELSİZ SERİSİ OYUN GRUBU

INCLUSIVE SERIES PLAY SYSTEMS

EF-453



1220

920



640

940



280

EF-454



1400

1100



520

820



480



EF-501

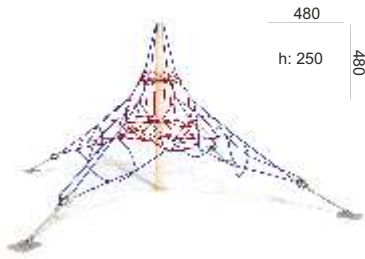

EF-502

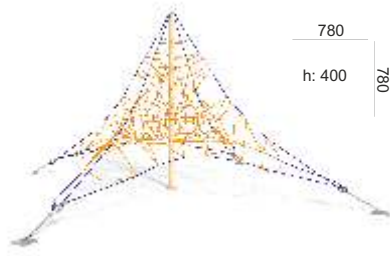

EF-503

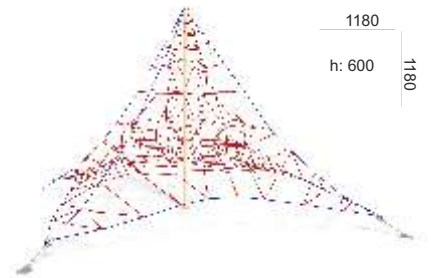

EF-504

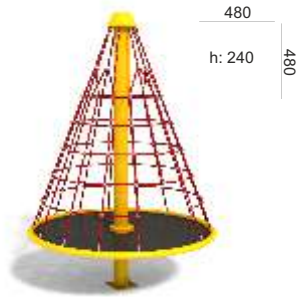

EF-505



EF-506

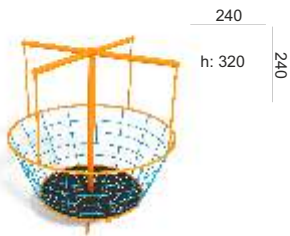

EF-507

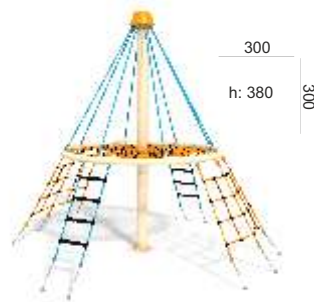

ROBOT SERİSİ OYUN GRUBU

ROBOT SERIES PLAY SYSTEMS

EF-151



EF-152



ROBOT SERIES PLAY SYSTEMS

ROBOT SERİSİ OYUN GRUBU

EF-153



950
650



870

570



510

EF-154



940
640



850

550



510



EF-141



EF-142



EF-131

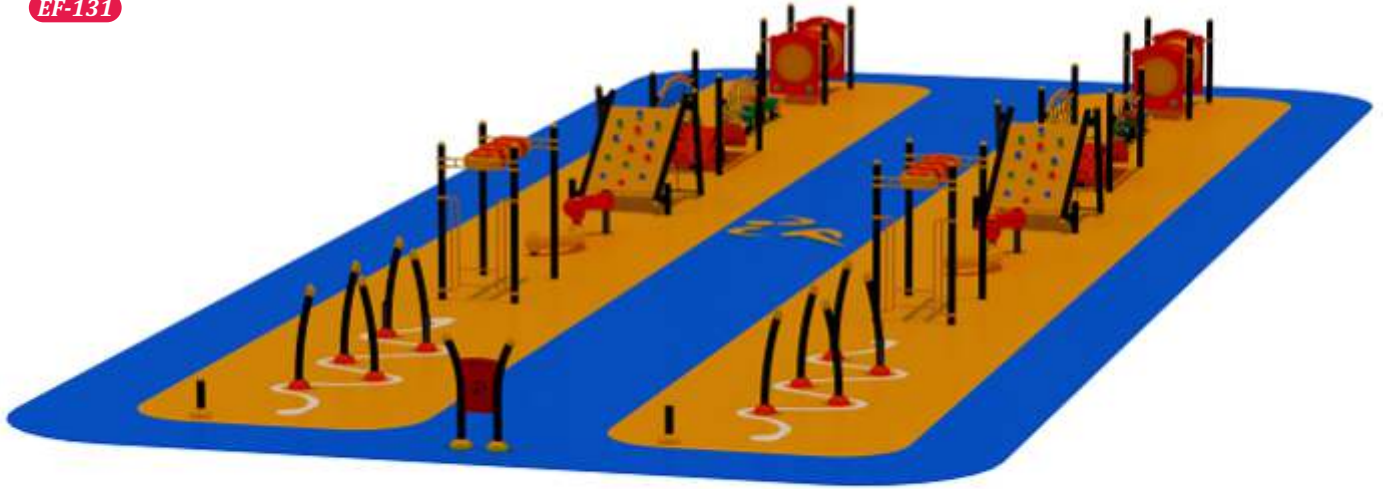

2400
2000

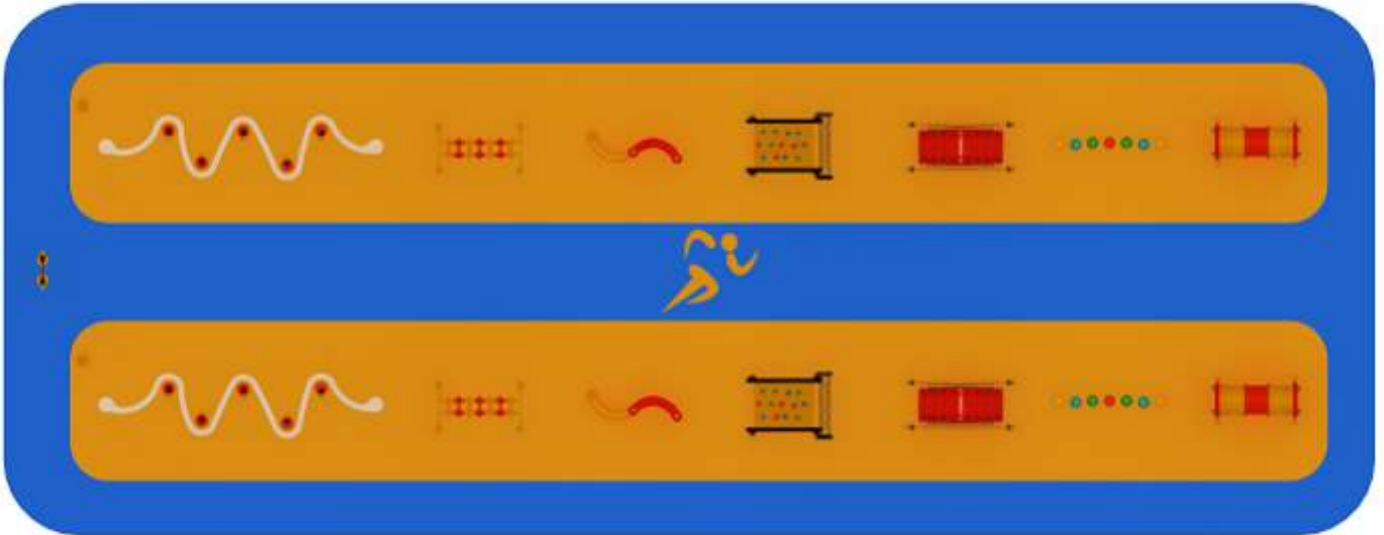

1000
600



EF-132



2400

2000



600

1000



TRACK SERIES PLAY SYSTEMS

PARKUR SERİSİ OYUN GRUBU

EF-133



1400
1000



1050
650

EF-133



2400
2000



1250
850



OYUN ELEMANLARI

PLAY EQUIPMENTS

EF-551



EF-552



EF-553

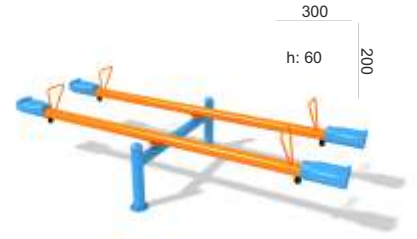

EF-554

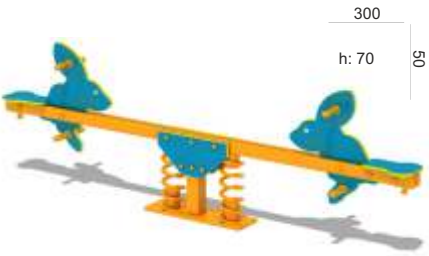

EF-555

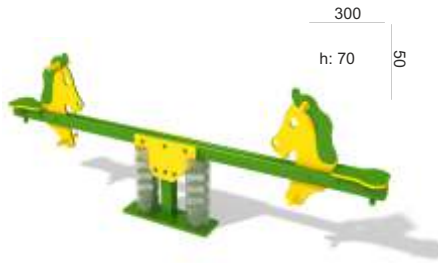

EF-557



EF-558



EF-559

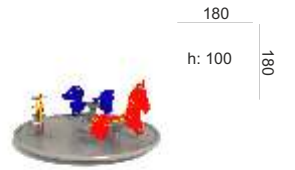

PLAY EQUIPMENTS

OYUN ELEMANLARI

EF-560



90
h: 80 30

EF-561



90
h: 100 90

EF-562



180
h: 140 120

EF-563



330
h: 250 120

EF-564



330
h: 250 120

EF-565



640
h: 250 120

EF-566



380
h: 250 140

EF-567



260
h: 250 120

EF-568



15000
h: 230 8500

EF-569



450
h: 280 400

EF-570



330
h: 250 120



TEKLİ FITNESS SERİSİ

SINGLE FITNESS SERIES

EF-601 İkili Bel Çevirme Aleti / Double Waist Turning Set



Genişlik Widness	120 cm
Derinlik Deepness	40 cm
Yükseklik Highness	125 cm

EF-602 Üçlü Bel Çevirme Aleti / Triple Waist Turning Set



Genişlik Widness	120 cm
Derinlik Deepness	120 cm
Yükseklik Highness	125 cm

EF-603 Bacak Açma Aleti / Leg Opening Set



Genişlik Widness	120 cm
Derinlik Deepness	50 cm
Yükseklik Highness	125 cm

EF-604 Bacak Ağırlık Aleti / Leg Weight



Genişlik Widness	75 cm
Derinlik Deepness	50 cm
Yükseklik Highness	95 cm

EF-605 Bacak Ağırlık ve Vücut Geliştirme Aleti / Leg Weight and Body Building Set



Genişlik Widness	165 cm
Derinlik Deepness	50 cm
Yükseklik Highness	180 cm



EF-606 Bacak Çalıştırma Aleti / Leg Exerciser Set



Genişlik Widness	150 cm
Derinlik Deepness	50 cm
Yükseklik Highness	180 cm

EF-607 Bisiklet Aleti / Bicycle



Genişlik Widness	90 cm
Derinlik Deepness	45 cm
Yükseklik Highness	110 cm

EF-608 Çiftli Havada Gezinim Aleti / Double Navigation Set



Genişlik Widness	150 cm
Derinlik Deepness	40 cm
Yükseklik Highness	155 cm

EF-609 Çift Yan Salınım Aleti / Double Sided Side Oscillation Set



Genişlik Widness	140 cm
Derinlik Deepness	60 cm
Yükseklik Highness	125 cm

EF-610 Eliptik Bisiklet Aleti / Elliptical Bicycle



Genişlik Widness	135 cm
Derinlik Deepness	50 cm
Yükseklik Highness	140 cm



TEKLİ FITNESS SERİSİ

SINGLE FITNESS SERIES

EF-611 İkili Vücut Geliştirme Aleti / Double Body Building Set



Genişlik Width	160 cm
Derinlik Depth	50 cm
Yükseklik Height	180 cm

EF-612 Jokey Aleti / Jockey



Genişlik Width	135 cm
Derinlik Depth	40 cm
Yükseklik Height	140 cm

EF-613 Kol - Bilek Çalıştırma Aleti / Arm - Wrist Training Set



Genişlik Width	90 cm
Derinlik Depth	85 cm
Yükseklik Height	140 cm

EF-614 Kürek Çekme Aleti / Rowing



Genişlik Width	140 cm
Derinlik Depth	60 cm
Yükseklik Height	90 cm

EF-615 Sırt Masaj Aleti / Back Massage Set



Genişlik Width	140 cm
Derinlik Depth	85 cm
Yükseklik Height	160 cm



EF-616 Step ve Bisiklet Aleti / Step and Bicycle Set



Genişlik Width	150 cm
Derinlik Deepness	65 cm
Yükseklik Highness	130 cm

EF-617 Şınav ve Mekik Aleti / Push-up and Shuttle Set



Genişlik Width	80 cm
Derinlik Deepness	80 cm
Yükseklik Highness	65 cm

EF-618 Uzay Yürüyüş Aleti / Space Walkers



Genişlik Width	90 cm
Derinlik Deepness	40 cm
Yükseklik Highness	120 cm

EF-619 Üçlü Vücut Geliştirme Aleti / Triple Body Building Set



Genişlik Width	90 cm
Derinlik Deepness	80 cm
Yükseklik Highness	200 cm



İKİLİ FITNESS SERİSİ

DOUBLE FITNESS SERIES

EF-651

Ayakta ve Oturarak Bel Çevirme Aleti
Standing and Sitting Waist Turning Set



Genişlik Width	130 cm
Derinlik Deepness	65 cm
Yükseklik Highness	200 cm

EF-652

Bacak Açma ve Bacak Ağırlık Aleti
Leg Spreading and Leg Weight Set



Genişlik Width	150 cm
Derinlik Deepness	65 cm
Yükseklik Highness	200 cm

EF-653

Bacak Açma ve Yan Salınım Aleti
Leg Spreading and Side Oscillation Set



Genişlik Width	150 cm
Derinlik Deepness	65 cm
Yükseklik Highness	200 cm

EF-654

Bacak Çalıştırma Aleti
Leg Exerciser Set



Genişlik Width	150 cm
Derinlik Deepness	65 cm
Yükseklik Highness	200 cm

EF-655

Bisiklet ve Jokey Aleti
Bicycle and Jockey Set



Genişlik Width	185 cm
Derinlik Deepness	65 cm
Yükseklik Highness	200 cm

EF-656

İkili Gezinim Aleti
Double Navigation Set



Genişlik Width	150 cm
Derinlik Deepness	75 cm
Yükseklik Highness	130 cm



EF-657

Kol - Bilek Çevirme Aleti
Arm - Wrist Turning Set



Genişlik Width	90 cm
Derinlik Deepness	65 cm
Yükseklik Highness	200 cm

EF-658

Kürek Çekme ve Uzay Yürüyüş Aleti
Rowing and Space Walker Set

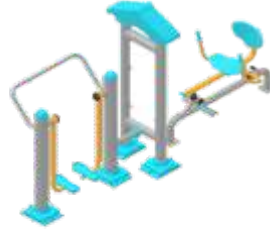

Genişlik Width	235 cm
Derinlik Deepness	65 cm
Yükseklik Highness	200 cm

EF-659

Oturarak Bel Çevirme ve Step Aleti
Seated Waist Rotation and Step Set



Genişlik Width	170 cm
Derinlik Deepness	65 cm
Yükseklik Highness	200 cm

EF-660

Sırt Masaj Aleti
Back Massager Set



Genişlik Width	170 cm
Derinlik Deepness	65 cm
Yükseklik Highness	200 cm

EF-661

Şınav Mekik ve Eliptik Bisiklet Aleti
Push-up Shuttle and Elliptical Bicycle Set



Genişlik Width	230 cm
Derinlik Deepness	65 cm
Yükseklik Highness	200 cm

EF-662

Vücut Geliştirme Aleti
Body Bulding Set



Genişlik Width	200 cm
Derinlik Deepness	65 cm
Yükseklik Highness	200 cm



ÜÇLÜ FITNESS SERİSİ

TRIPLE FITNESS SERIES

EF-701 Bacak Ağırlık, Bacak Açma ve Step Aleti
Leg Weight Spread and Step Set



Genişlik Width	150 cm
Derinlik Depth	140 cm
Yükseklik Height	200 cm

EF-702 Kol - Bilek Çevirme ve Oturarak Bel Çevirme Aleti
Arm - Wrist Twist and Seated Waist Flip Set



Genişlik Width	140 cm
Derinlik Depth	140 cm
Yükseklik Height	200 cm

EF-703 Sırt Masaj ve Ayakta Bel Çevirme Aleti
Back Massage and Standing Waist Rotation Set

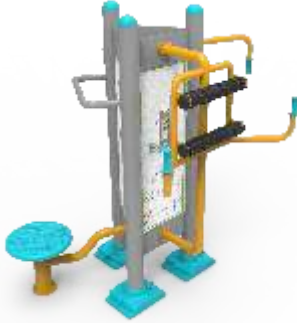

Genişlik Width	145 cm
Derinlik Depth	165 cm
Yükseklik Height	200 cm

EF-704 Uzay Yürüyüşü, Bisiklet ve Kürek Çekme Aleti
Space Walker, Bicycle and Rowing Set



Genişlik Width	260 cm
Derinlik Depth	200 cm
Yükseklik Height	200 cm

EF-705 Yan Salınım, Vücut Geliştirme ve Bacak Çalıştırma Aleti
Side Swing, Body Building and Leg Training Set



Genişlik Width	220 cm
Derinlik Depth	180 cm
Yükseklik Height	200 cm



DOUBLE FITNESS

EF-711



Geniřlik Widness	600 cm
Derinlik Deepness	550 cm
Yükseklik Highness	275 cm



FITNESS STATION

EF-721



Geniřlik Widness	600 cm
Derinlik Deepness	330 cm
Yükseklik Highness	210 cm

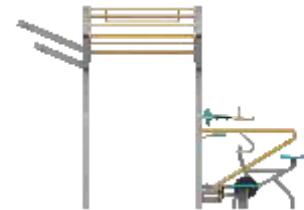
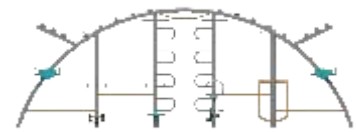
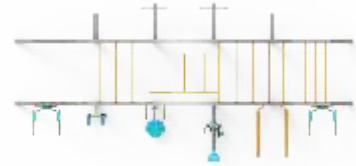

EF-751



Genişlik Width	120 cm
Derinlik Deepness	40 cm
Yükseklik Highness	140 cm

EF-752



Genişlik Width	120 cm
Derinlik Deepness	40 cm
Yükseklik Highness	120 cm

EF-753



Genişlik Width	120 cm
Derinlik Deepness	40 cm
Yükseklik Highness	120 cm

EF-754



Genişlik Width	150 cm
Derinlik Deepness	60 cm
Yükseklik Highness	130 cm

EF-755



Genişlik Width	130 cm
Derinlik Deepness	70 cm
Yükseklik Highness	120 cm



EF-801



Genişlik Widness	140 cm
Derinlik Deepness	50 cm
Yükseklik Highness	200 cm

EF-802



Genişlik Widness	185 cm
Derinlik Deepness	60 cm
Yükseklik Highness	200 cm

EF-803



Genişlik Widness	100 cm
Derinlik Deepness	80 cm
Yükseklik Highness	200 cm

EF-804



Genişlik Widness	100 cm
Derinlik Deepness	65 cm
Yükseklik Highness	200 cm

EF-805



Genişlik Widness	160 cm
Derinlik Deepness	160 cm
Yükseklik Highness	200 cm





BENCHES

BANKLAR



— www.gamainsaat.com —

EF-846



Genişlik Widness	157 cm	Malzeme Material	Alüminyum Döküm Aluminum Casting
Derinlik Deepness	68 cm	Uygulanan Boya Applied Paint	Elektrostatik Toz Boya Elektrostatic Powder Coating
Yükseklik Highness	87 cm	Ahşap Wood	1. Sınıf Emprenyeli Çam Impregnated Pine

EF-847



Genişlik Widness	165 cm	Malzeme Material	ST 37 Metal ST 37 Metal
Derinlik Deepness	70 cm	Uygulanan Boya Applied Paint	Elektrostatik Toz Boya Elektrostatic Powder Coating
Yükseklik Highness	71 cm	Ahşap Wood	1. Sınıf Emprenyeli Çam Impregnated Pine

EF-848



Genişlik Widness	145 cm	Malzeme Material	ST 37 Metal ST 37 Metal
Derinlik Deepness	61 cm	Uygulanan Boya Applied Paint	Elektrostatik Toz Boya Elektrostatic Powder Coating
Yükseklik Highness	76 cm	Ahşap Wood	1. Sınıf Emprenyeli Çam Impregnated Pine

EF-849



Genişlik Widness	157 cm	Malzeme Material	ST 37 Metal ST 37 Metal
Derinlik Deepness	61 cm	Uygulanan Boya Applied Paint	Elektrostatik Toz Boya Elektrostatic Powder Coating
Yükseklik Highness	84 cm	Ahşap Wood	1. Sınıf Emprenyeli Çam Impregnated Pine

EF-850



Genişlik Widness	145 cm	Malzeme Material	ST 37 Metal ST 37 Metal
Derinlik Deepness	42 cm	Uygulanan Boya Applied Paint	Elektrostatik Toz Boya Elektrostatic Powder Coating
Yükseklik Highness	75 cm	Ahşap Wood	1. Sınıf Emprenyeli Çam Impregnated Pine

EF-851



Genişlik Widness	145 cm	Malzeme Material	ST 37 Metal ST 37 Metal
Derinlik Deepness	42 cm	Uygulanan Boya Applied Paint	Elektrostatik Toz Boya Elektrostatic Powder Coating
Yükseklik Highness	45 cm	Ahşap Wood	1. Sınıf Emprenyeli Çam Impregnated Pine



BANKLAR

BENCHES

EF-852



Genişlik Widness	152 cm	Malzeme Material	ST 37 Metal
Derinlik Deepness	47 cm	Uygulanan Boya Applied Paint	Elektrostatik Toz Boya Elektrostatic Powder Coating
Yükseklik Highness	72 cm	Ahşap Wood	1. Sınıf Emprenyeli Çam Impregnated Pine

EF-853



Genişlik Widness	145 cm	Malzeme Material	Alüminyum Döküm Aluminum Casting
Derinlik Deepness	52 cm	Uygulanan Boya Applied Paint	Elektrostatik Toz Boya Elektrostatic Powder Coating
Yükseklik Highness	71 cm	Ahşap Wood	1. Sınıf Emprenyeli Çam Impregnated Pine

EF-854



Genişlik Widness	152 cm	Malzeme Material	ST 37 Metal
Derinlik Deepness	56 cm	Uygulanan Boya Applied Paint	Elektrostatik Toz Boya Elektrostatic Powder Coating
Yükseklik Highness	83 cm	Ahşap Wood	1. Sınıf Emprenyeli Çam Impregnated Pine

EF-855



Genişlik Widness	145 cm	Malzeme Material	Alüminyum Döküm Aluminum Casting
Derinlik Deepness	54 cm	Uygulanan Boya Applied Paint	Elektrostatik Toz Boya Elektrostatic Powder Coating
Yükseklik Highness	57 cm	Ahşap Wood	1. Sınıf Emprenyeli Çam Impregnated Pine

EF-856



Genişlik Widness	152 cm	Malzeme Material	ST 37 Metal
Derinlik Deepness	47 cm	Uygulanan Boya Applied Paint	Elektrostatik Toz Boya Elektrostatic Powder Coating
Yükseklik Highness	45 cm	Ahşap Wood	1. Sınıf Emprenyeli Çam Impregnated Pine

EF-857



Genişlik Widness	147 cm	Malzeme Material	Alüminyum Döküm Aluminum Casting
Derinlik Deepness	55 cm	Uygulanan Boya Applied Paint	Elektrostatik Toz Boya Elektrostatic Powder Coating
Yükseklik Highness	78 cm	Ahşap Wood	1. Sınıf Emprenyeli Çam Impregnated Pine



EF-858



Genişlik Widness	147 cm	Malzeme Material	ST 37 Metal ST 37 Metal
Derinlik Deepness	50 cm	Uygulanan Boya Applied Paint	Elektrostatik Toz Boya Elektrostatic Powder Coating
Yükseklik Highness	53 cm	Ahşap Wood	1. Sınıf Emprenyeli Çam Impregnated Pine

EF-859



Genişlik Widness	147 cm	Malzeme Material	Alüminyum Döküm Aluminum Casting
Derinlik Deepness	59 cm	Uygulanan Boya Applied Paint	Elektrostatik Toz Boya Elektrostatic Powder Coating
Yükseklik Highness	75 cm	Ahşap Wood	1. Sınıf Emprenyeli Çam Impregnated Pine

EF-860



Genişlik Widness	145 cm	Malzeme Material	ST 37 Metal ST 37 Metal
Derinlik Deepness	52 cm	Uygulanan Boya Applied Paint	Elektrostatik Toz Boya Elektrostatic Powder Coating
Yükseklik Highness	77 cm	Ahşap Wood	1. Sınıf Emprenyeli Çam Impregnated Pine

EF-861



Genişlik Widness	145 cm	Malzeme Material	Alüminyum Döküm Aluminum Casting
Derinlik Deepness	61 cm	Uygulanan Boya Applied Paint	Elektrostatik Toz Boya Elektrostatic Powder Coating
Yükseklik Highness	76 cm	Ahşap Wood	1. Sınıf Emprenyeli Çam Impregnated Pine

EF-862



Genişlik Widness	147 cm	Malzeme Material	Alüminyum Döküm Aluminum Casting
Derinlik Deepness	61 cm	Uygulanan Boya Applied Paint	Elektrostatik Toz Boya Elektrostatic Powder Coating
Yükseklik Highness	71 cm	Ahşap Wood	1. Sınıf Emprenyeli Çam Impregnated Pine

EF-863



Genişlik Widness	147 cm	Malzeme Material	Alüminyum Döküm Aluminum Casting
Derinlik Deepness	55 cm	Uygulanan Boya Applied Paint	Elektrostatik Toz Boya Elektrostatic Powder Coating
Yükseklik Highness	78 cm	Ahşap Wood	1. Sınıf Emprenyeli Çam Impregnated Pine



BANKLAR

BENCHES

EF-864



Genişlik Widness	150 cm	Malzeme Material	ST 37 Metal ST 37 Metal
Derinlik Deepness	53 cm	Uygulanan Boya Applied Paint	Elektrostatik Toz Boya Elektrostatic Powder Coating
Yükseklik Highness	58 cm	Ahşap Wood	1. Sınıf Emprenyeli Çam Impregnated Pine

EF-865



Genişlik Widness	150 cm	Malzeme Material	Paslanmaz Çelik Stainless Steel
Derinlik Deepness	53 cm	Uygulanan Boya Applied Paint	
Yükseklik Highness	58 cm	Ahşap Wood	1. Sınıf Emprenyeli Çam Impregnated Pine

EF-866

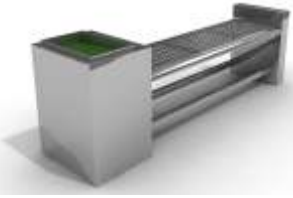

Genişlik Widness	195 cm	Malzeme Material	Paslanmaz Çelik Stainless Steel
Derinlik Deepness	50 cm	Uygulanan Boya Applied Paint	
Yükseklik Highness	62 cm	Ahşap Wood	1. Sınıf Emprenyeli Çam Impregnated Pine

EF-867



Genişlik Widness	300 cm	Malzeme Material	ST 37 Metal ST 37 Metal
Derinlik Deepness	150 cm	Uygulanan Boya Applied Paint	Elektrostatik Toz Boya Elektrostatic Powder Coating
Yükseklik Highness	45 cm	Ahşap Wood	1. Sınıf Emprenyeli Çam Impregnated Pine

EF-868



Genişlik Widness	195 cm	Malzeme Material	Paslanmaz Çelik Stainless Steel
Derinlik Deepness	45 cm	Uygulanan Boya Applied Paint	Elektrostatik Toz Boya Elektrostatic Powder Coating
Yükseklik Highness	66 cm	Ahşap Wood	1. Sınıf Emprenyeli Çam Impregnated Pine

EF-869



Genişlik Widness	195 cm	Malzeme Material	ST 37 Metal ST 37 Metal
Derinlik Deepness	45 cm	Uygulanan Boya Applied Paint	Elektrostatik Toz Boya Elektrostatic Powder Coating
Yükseklik Highness	66 cm	Ahşap Wood	1. Sınıf Emprenyeli Çam Impregnated Pine



EF-872



Genişlik Widness	155 cm	Malzeme Material	Paslanmaz Çelik Stainless Steel
Derinlik Deepness	40 cm	Uygulanan Boya Applied Paint	
Yükseklik Highness	45 cm	Ahşap Wood	1. Sınıf Emprenyeli Çam Impregnated Pine

EF-873



Genişlik Widness	155 cm	Malzeme Material	ST 37 Metal ST 37 Metal
Derinlik Deepness	40 cm	Uygulanan Boya Applied Paint	Elektrostatik Toz Boya Elektrostatic Powder Coating
Yükseklik Highness	45 cm	Ahşap Wood	1. Sınıf Emprenyeli Çam Impregnated Pine

EF-874



Genişlik Widness	155 cm	Malzeme Material	ST 37 Metal ST 37 Metal
Derinlik Deepness	40 cm	Uygulanan Boya Applied Paint	Elektrostatik Toz Boya Elektrostatic Powder Coating
Yükseklik Highness	45 cm	Ahşap Wood	1. Sınıf Emprenyeli Çam Impregnated Pine

EF-875



Genişlik Widness	155 cm	Malzeme Material	Paslanmaz Çelik Stainless Steel
Derinlik Deepness	40 cm	Uygulanan Boya Applied Paint	
Yükseklik Highness	45 cm	Ahşap Wood	1. Sınıf Emprenyeli Çam Impregnated Pine

EF-876



Genişlik Widness	200 cm	Malzeme Material	ST 37 Metal ST 37 Metal
Derinlik Deepness	45 cm	Uygulanan Boya Applied Paint	Elektrostatik Toz Boya Elektrostatic Powder Coating
Yükseklik Highness	58 cm	Ahşap Wood	1. Sınıf Emprenyeli Çam Impregnated Pine

EF-877



Genişlik Widness	200 cm	Malzeme Material	Paslanmaz Çelik Stainless Steel
Derinlik Deepness	45 cm	Uygulanan Boya Applied Paint	
Yükseklik Highness	58 cm	Ahşap Wood	1. Sınıf Emprenyeli Çam Impregnated Pine





LITTER BINS

ÇÖP KOVALARI



— www.gamainsaat.com —

EF-901



Genişlik Widness	44 cm	Malzeme Material	ST 37 Metal ST 37 Metal
Derinlik Deepness	49 cm	Uygulanan Boya Applied Paint	Elektrostatik Toz Boya Elektrostatic Powder Coating
Yükseklik Highness	105 cm	Ahşap Wood	

EF-902



Genişlik Widness	44 cm	Malzeme Material	ST 37 Metal ST 37 Metal
Derinlik Deepness	45 cm	Uygulanan Boya Applied Paint	Elektrostatik Toz Boya Elektrostatic Powder Coating
Yükseklik Highness	105 cm	Ahşap Wood	

EF-903



Genişlik Widness	44 cm	Malzeme Material	ST 37 Metal ST 37 Metal
Derinlik Deepness	45 cm	Uygulanan Boya Applied Paint	Elektrostatik Toz Boya Elektrostatic Powder Coating
Yükseklik Highness	105 cm	Ahşap Wood	

EF-904



Genişlik Widness	38 cm	Malzeme Material	ST 37 Metal ST 37 Metal
Derinlik Deepness	46 cm	Uygulanan Boya Applied Paint	Elektrostatik Toz Boya Elektrostatic Powder Coating
Yükseklik Highness	85 cm	Ahşap Wood	

EF-905



Genişlik Widness	44 cm	Malzeme Material	ST 37 Metal ST 37 Metal
Derinlik Deepness	45 cm	Uygulanan Boya Applied Paint	Elektrostatik Toz Boya Elektrostatic Powder Coating
Yükseklik Highness	67 cm	Ahşap Wood	



ÇÖP KOVALARI

LITTER BINS

EF-906



Genişlik Widness	44 cm	Malzeme Material	ST 37 Metal
Derinlik Deepness	45 cm	Uygulanan Boya Applied Paint	Elektrostatik Toz Boya Elektrostatic Powder Coating
Yükseklik Highness	67 cm	Ahşap Wood	

EF-907



Genişlik Widness	44 cm	Malzeme Material	ST 37 Metal
Derinlik Deepness	44 cm	Uygulanan Boya Applied Paint	Elektrostatik Toz Boya Elektrostatic Powder Coating
Yükseklik Highness	70 cm	Ahşap Wood	

EF-908



Genişlik Widness	34 cm	Malzeme Material	ST 37 Metal
Derinlik Deepness	34 cm	Uygulanan Boya Applied Paint	Elektrostatik Toz Boya Elektrostatic Powder Coating
Yükseklik Highness	62 cm	Ahşap Wood	

EF-909



Genişlik Widness	44 cm	Malzeme Material	ST 37 Metal
Derinlik Deepness	29 cm	Uygulanan Boya Applied Paint	Elektrostatik Toz Boya Elektrostatic Powder Coating
Yükseklik Highness	110 cm	Ahşap Wood	

EF-910



Genişlik Widness	44 cm	Malzeme Material	ST 37 Metal
Derinlik Deepness	29 cm	Uygulanan Boya Applied Paint	Elektrostatik Toz Boya Elektrostatic Powder Coating
Yükseklik Highness	110 cm	Ahşap Wood	

EF-911



Genişlik Widness	44 cm	Malzeme Material	ST 37 Metal
Derinlik Deepness	29 cm	Uygulanan Boya Applied Paint	Elektrostatik Toz Boya Elektrostatic Powder Coating
Yükseklik Highness	110 cm	Ahşap Wood	



EF-912



Genişlik Widness	44 cm	Malzeme Material	ST 37 Metal
Derinlik Deepness	29 cm	Uygulanan Boya Applied Paint	Elektrostatik Toz Boya Elektrostatic Powder Coating
Yükseklik Highness	110 cm	Ahşap Wood	

EF-913



Genişlik Widness	44 cm	Malzeme Material	ST 37 Metal
Derinlik Deepness	29 cm	Uygulanan Boya Applied Paint	Elektrostatik Toz Boya Elektrostatic Powder Coating
Yükseklik Highness	85 cm	Ahşap Wood	

EF-914



Genişlik Widness	44 cm	Malzeme Material	ST 37 Metal
Derinlik Deepness	29 cm	Uygulanan Boya Applied Paint	Elektrostatik Toz Boya Elektrostatic Powder Coating
Yükseklik Highness	85 cm	Ahşap Wood	

EF-915



Genişlik Widness	44 cm	Malzeme Material	ST 37 Metal
Derinlik Deepness	29 cm	Uygulanan Boya Applied Paint	Elektrostatik Toz Boya Elektrostatic Powder Coating
Yükseklik Highness	85 cm	Ahşap Wood	

EF-916



Genişlik Widness	45 cm	Malzeme Material	ST 37 Metal
Derinlik Deepness	45 cm	Uygulanan Boya Applied Paint	Elektrostatik Toz Boya Elektrostatic Powder Coating
Yükseklik Highness	65 cm	Ahşap Wood	

EF-917



Genişlik Widness	45 cm	Malzeme Material	ST 37 Metal
Derinlik Deepness	45 cm	Uygulanan Boya Applied Paint	Elektrostatik Toz Boya Elektrostatic Powder Coating
Yükseklik Highness	65 cm	Ahşap Wood	



ÇÖP KOVALARI

LITTER BINS

EF-918



Genişlik Widness	36 cm	Malzeme Material	ST 37 Metal
Derinlik Deepness	36 cm	Uygulanan Boya Applied Paint	Elektrostatik Toz Boya Elektrostatic Powder Coating
Yükseklik Highness	60 cm	Ahşap Wood	

EF-919



Genişlik Widness	36 cm	Malzeme Material	ST 37 Metal
Derinlik Deepness	36 cm	Uygulanan Boya Applied Paint	Elektrostatik Toz Boya Elektrostatic Powder Coating
Yükseklik Highness	60 cm	Ahşap Wood	

EF-920



Genişlik Widness	30 cm	Malzeme Material	ST 37 Metal
Derinlik Deepness	30 cm	Uygulanan Boya Applied Paint	Elektrostatik Toz Boya Elektrostatic Powder Coating
Yükseklik Highness	70 cm	Ahşap Wood	1. Sınıf Emprenyeli Çam Impregnated Pine

EF-921



Genişlik Widness	34 cm	Malzeme Material	ST 37 Metal
Derinlik Deepness	44 cm	Uygulanan Boya Applied Paint	Elektrostatik Toz Boya Elektrostatic Powder Coating
Yükseklik Highness	80 cm	Ahşap Wood	1. Sınıf Emprenyeli Çam Impregnated Pine

EF-922



Genişlik Widness	36 cm	Malzeme Material	ST 37 Metal
Derinlik Deepness	36 cm	Uygulanan Boya Applied Paint	Elektrostatik Toz Boya Elektrostatic Powder Coating
Yükseklik Highness	66 cm	Ahşap Wood	1. Sınıf Emprenyeli Çam Impregnated Pine

EF-923



Genişlik Widness	50 cm	Malzeme Material	ST 37 Metal
Derinlik Deepness	50 cm	Uygulanan Boya Applied Paint	Elektrostatik Toz Boya Elektrostatic Powder Coating
Yükseklik Highness	60 cm	Ahşap Wood	1. Sınıf Emprenyeli Çam Impregnated Pine



EF-924



Genişlik Widness	38 cm	Malzeme Material	ST 37 Metal
Derinlik Deepness	38 cm	Uygulanan Boya Applied Paint	Elektrostatik Toz Boya Elektrostatic Powder Coating
Yükseklik Highness	63 cm	Ahşap Wood	1. Sınıf Emprenyeli Çam Impregnated Pine

EF-925



Genişlik Widness	37 cm	Malzeme Material	ST 37 Metal
Derinlik Deepness	37 cm	Uygulanan Boya Applied Paint	Elektrostatik Toz Boya Elektrostatic Powder Coating
Yükseklik Highness	68 cm	Ahşap Wood	1. Sınıf Emprenyeli Çam Impregnated Pine

EF-926



Genişlik Widness	37 cm	Malzeme Material	ST 37 Metal
Derinlik Deepness	37 cm	Uygulanan Boya Applied Paint	Elektrostatik Toz Boya Elektrostatic Powder Coating
Yükseklik Highness	65 cm	Ahşap Wood	1. Sınıf Emprenyeli Çam Impregnated Pine

EF-927



Genişlik Widness	45 cm	Malzeme Material	ST 37 Metal
Derinlik Deepness	45 cm	Uygulanan Boya Applied Paint	Elektrostatik Toz Boya Elektrostatic Powder Coating
Yükseklik Highness	68 cm	Ahşap Wood	1. Sınıf Emprenyeli Çam Impregnated Pine

EF-928



Genişlik Widness	37 cm	Malzeme Material	ST 37 Metal
Derinlik Deepness	37 cm	Uygulanan Boya Applied Paint	Elektrostatik Toz Boya Elektrostatic Powder Coating
Yükseklik Highness	59 cm	Ahşap Wood	1. Sınıf Emprenyeli Çam Impregnated Pine

EF-929



Genişlik Widness	34 cm	Malzeme Material	ST 37 Metal
Derinlik Deepness	45 cm	Uygulanan Boya Applied Paint	Elektrostatik Toz Boya Elektrostatic Powder Coating
Yükseklik Highness	100 cm	Ahşap Wood	1. Sınıf Emprenyeli Çam Impregnated Pine



ÇÖP KOVALARI

LITTER BINS

EF-930

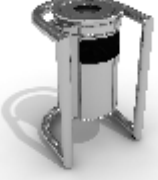

Genişlik Widness	44 cm	Malzeme Material	Paslanmaz Çelik Stainless Steel
Derinlik Deepness	44 cm	Uygulanan Boya Applied Paint	
Yükseklik Highness	70 cm	Ahşap Wood	

EF-931



Genişlik Widness	44 cm	Malzeme Material	Paslanmaz Çelik Stainless Steel
Derinlik Deepness	44 cm	Uygulanan Boya Applied Paint	
Yükseklik Highness	70 cm	Ahşap Wood	

EF-932



Genişlik Widness	44 cm	Malzeme Material	Paslanmaz Çelik Stainless Steel
Derinlik Deepness	44 cm	Uygulanan Boya Applied Paint	
Yükseklik Highness	70 cm	Ahşap Wood	

EF-933



Genişlik Widness	44 cm	Malzeme Material	Paslanmaz Çelik Stainless Steel
Derinlik Deepness	45 cm	Uygulanan Boya Applied Paint	
Yükseklik Highness	105 cm	Ahşap Wood	

EF-934



Genişlik Widness	44 cm	Malzeme Material	Paslanmaz Çelik Stainless Steel
Derinlik Deepness	45 cm	Uygulanan Boya Applied Paint	
Yükseklik Highness	105 cm	Ahşap Wood	

EF-935



Genişlik Widness	44 cm	Malzeme Material	Paslanmaz Çelik Stainless Steel
Derinlik Deepness	45 cm	Uygulanan Boya Applied Paint	
Yükseklik Highness	105 cm	Ahşap Wood	



EF-936



Genişlik Widness	60 cm	Malzeme Material	Paslanmaz Çelik Stainless Steel
Derinlik Deepness	40 cm	Uygulanan Boya Applied Paint	
Yükseklik Highness	40 cm	Ahşap Wood	

EF-937



Genişlik Widness	66 cm	Malzeme Material	Paslanmaz Çelik Stainless Steel
Derinlik Deepness	46 cm	Uygulanan Boya Applied Paint	
Yükseklik Highness	40 cm	Ahşap Wood	

EF-938



Genişlik Widness	40 cm	Malzeme Material	Paslanmaz Çelik Stainless Steel
Derinlik Deepness	40 cm	Uygulanan Boya Applied Paint	
Yükseklik Highness	40 cm	Ahşap Wood	



SAKSILAR

FLOWER POTS

EF-939



Genişlik Width	40 cm	Malzeme Material	Paslanmaz Çelik Stainless Steel
Derinlik Deepness	40 cm	Uygulanan Boya Applied Paint	
Yükseklik Highness	43 cm	Ahşap Wood	

EF-940



Genişlik Width	40 cm	Malzeme Material	Paslanmaz Çelik Stainless Steel
Derinlik Deepness	40 cm	Uygulanan Boya Applied Paint	
Yükseklik Highness	40 cm	Ahşap Wood	

EF-941



Genişlik Width	44 cm	Malzeme Material	Paslanmaz Çelik Stainless Steel
Derinlik Deepness	40 cm	Uygulanan Boya Applied Paint	
Yükseklik Highness	40 cm	Ahşap Wood	



EF-942



Genişlik Widness	50 cm	Malzeme Material	Paslanmaz Çelik Stainless Steel
Derinlik Deepness	50 cm	Uygulanan Boya Applied Paint	
Yükseklik Highness	40 cm	Ahşap Wood	

EF-943

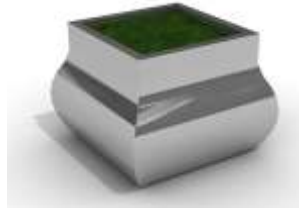

Genişlik Widness	50 cm	Malzeme Material	Paslanmaz Çelik Stainless Steel
Derinlik Deepness	50 cm	Uygulanan Boya Applied Paint	
Yükseklik Highness	40 cm	Ahşap Wood	

EF-944

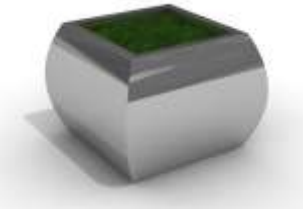

Genişlik Widness	50 cm	Malzeme Material	Paslanmaz Çelik Stainless Steel
Derinlik Deepness	50 cm	Uygulanan Boya Applied Paint	
Yükseklik Highness	40 cm	Ahşap Wood	

EF-945



Genişlik Widness	40 cm	Malzeme Material	Paslanmaz Çelik Stainless Steel
Derinlik Deepness	40 cm	Uygulanan Boya Applied Paint	
Yükseklik Highness	40 cm	Ahşap Wood	

EF-946



Genişlik Widness	40 cm	Malzeme Material	Paslanmaz Çelik Stainless Steel
Derinlik Deepness	40 cm	Uygulanan Boya Applied Paint	
Yükseklik Highness	40 cm	Ahşap Wood	

EF-947



Genişlik Widness	100 cm	Malzeme Material	Paslanmaz Çelik Stainless Steel
Derinlik Deepness	40 cm	Uygulanan Boya Applied Paint	
Yükseklik Highness	40 cm	Ahşap Wood	





RECYCLING BINS

GERİ DÖNÜŞÜM KOVALARI



www.gamainsaat.com

EF-951



Genişlik Widness	132 cm	Malzeme Material	ST 37 Metal
Derinlik Deepness	29 cm	Uygulanan Boya Applied Paint	Elektrostatik Toz Boya Elektrostatic Powder Coating
Yükseklik Highness	115 cm	Ahşap Wood	

EF-952



Genişlik Widness	122 cm	Malzeme Material	ST 37 Metal
Derinlik Deepness	29 cm	Uygulanan Boya Applied Paint	Elektrostatik Toz Boya Elektrostatic Powder Coating
Yükseklik Highness	85 cm	Ahşap Wood	

EF-953



Genişlik Widness	45 cm	Malzeme Material	ST 37 Metal
Derinlik Deepness	45 cm	Uygulanan Boya Applied Paint	Elektrostatik Toz Boya Elektrostatic Powder Coating
Yükseklik Highness	65 cm	Ahşap Wood	

EF-954



Genişlik Widness	38 cm	Malzeme Material	ST 37 Metal
Derinlik Deepness	38 cm	Uygulanan Boya Applied Paint	Elektrostatik Toz Boya Elektrostatic Powder Coating
Yükseklik Highness	63 cm	Ahşap Wood	1. Sınıf Emprenyeli Çam Impregnated Pine

EF-955



Genişlik Widness	48 cm	Malzeme Material	ST 37 Metal
Derinlik Deepness	48 cm	Uygulanan Boya Applied Paint	Elektrostatik Toz Boya Elektrostatic Powder Coating
Yükseklik Highness	67 cm	Ahşap Wood	1. Sınıf Emprenyeli Çam Impregnated Pine

EF-956



Genişlik Widness	100 cm	Malzeme Material	ST 37 Metal
Derinlik Deepness	48 cm	Uygulanan Boya Applied Paint	Elektrostatik Toz Boya Elektrostatic Powder Coating
Yükseklik Highness	67 cm	Ahşap Wood	1. Sınıf Emprenyeli Çam Impregnated Pine



GERİ DÖNÜŞÜM KUTULARI

RECYCLING BINS

EF-957



Genişlik Widness	64 cm	Malzeme Material	ST 37 Metal ST 37 Metal
Derinlik Deepness	64 cm	Uygulanan Boya Applied Paint	Elektrostatik Toz Boya Elektrostatic Powder Coating
Yükseklik Highness	75 cm	Ahşap Wood	

EF-958



Genişlik Widness	64 cm	Malzeme Material	ST 37 Metal ST 37 Metal
Derinlik Deepness	64 cm	Uygulanan Boya Applied Paint	Elektrostatik Toz Boya Elektrostatic Powder Coating
Yükseklik Highness	75 cm	Ahşap Wood	

EF-959



Genişlik Widness	110 cm	Malzeme Material	Paslanmaz Çelik Stainless Steel
Derinlik Deepness	40 cm	Uygulanan Boya Applied Paint	
Yükseklik Highness	90 cm	Ahşap Wood	1. Sınıf Emprenyeli Çam Impregnated Pine

EF-960



Genişlik Widness	110 cm	Malzeme Material	ST 37 Metal ST 37 Metal
Derinlik Deepness	40 cm	Uygulanan Boya Applied Paint	Elektrostatik Toz Boya Elektrostatic Powder Coating
Yükseklik Highness	90 cm	Ahşap Wood	1. Sınıf Emprenyeli Çam Impregnated Pine

EF-961



Genişlik Widness	30 cm	Malzeme Material	ST 37 Metal ST 37 Metal
Derinlik Deepness	30 cm	Uygulanan Boya Applied Paint	Elektrostatik Toz Boya Elektrostatic Powder Coating
Yükseklik Highness	70 cm	Ahşap Wood	1. Sınıf Emprenyeli Çam Impregnated Pine

EF-962



Genişlik Widness	30 cm	Malzeme Material	Paslanmaz Çelik Stainless Steel
Derinlik Deepness	30 cm	Uygulanan Boya Applied Paint	
Yükseklik Highness	70 cm	Ahşap Wood	1. Sınıf Emprenyeli Çam Impregnated Pine



EF-963



Genişlik Widness	96 cm	Malzeme Material	ST 37 Metal ST 37 Metal
Derinlik Deepness	32 cm	Uygulanan Boya Applied Paint	Elektrostatik Toz Boya Elektrostatic Powder Coating
Yükseklik Highness	72 cm	Ahşap Wood	

EF-964



Genişlik Widness	122 cm	Malzeme Material	ST 37 Metal ST 37 Metal
Derinlik Deepness	29 cm	Uygulanan Boya Applied Paint	Elektrostatik Toz Boya Elektrostatic Powder Coating
Yükseklik Highness	90 cm	Ahşap Wood	

EF-965



Genişlik Widness	25 cm	Malzeme Material	ST 37 Metal ST 37 Metal
Derinlik Deepness	25 cm	Uygulanan Boya Applied Paint	Elektrostatik Toz Boya Elektrostatic Powder Coating
Yükseklik Highness	77 cm	Ahşap Wood	

EF-966



Genişlik Widness	25 cm	Malzeme Material	ST 37 Metal ST 37 Metal
Derinlik Deepness	25 cm	Uygulanan Boya Applied Paint	Elektrostatik Toz Boya Elektrostatic Powder Coating
Yükseklik Highness	77 cm	Ahşap Wood	

EF-967



Genişlik Widness	62 cm	Malzeme Material	Paslanmaz Çelik Stainless Steel
Derinlik Deepness	33 cm	Uygulanan Boya Applied Paint	
Yükseklik Highness	64 cm	Ahşap Wood	

EF-968



Genişlik Widness	93 cm	Malzeme Material	Paslanmaz Çelik Stainless Steel
Derinlik Deepness	33 cm	Uygulanan Boya Applied Paint	
Yükseklik Highness	64 cm	Ahşap Wood	



GERİ DÖNÜŞÜM KUTULARI

RECYCLING BINS

EF-969



Genişlik Widness	66 cm	Malzeme Material	ST 37 Metal ST 37 Metal
Derinlik Deepness	48 cm	Uygulanan Boya Applied Paint	Elektrostatik Toz Boya Elektrostatic Powder Coating
Yükseklik Highness	67 cm	Ahşap Wood	

EF-970



Genişlik Widness	99 cm	Malzeme Material	ST 37 Metal ST 37 Metal
Derinlik Deepness	48 cm	Uygulanan Boya Applied Paint	Elektrostatik Toz Boya Elektrostatic Powder Coating
Yükseklik Highness	67 cm	Ahşap Wood	

EF-971



Genişlik Widness	133 cm	Malzeme Material	ST 37 Metal ST 37 Metal
Derinlik Deepness	48 cm	Uygulanan Boya Applied Paint	Elektrostatik Toz Boya Elektrostatic Powder Coating
Yükseklik Highness	67 cm	Ahşap Wood	

EF-972



Genişlik Widness	66 cm	Malzeme Material	ST 37 Metal ST 37 Metal
Derinlik Deepness	48 cm	Uygulanan Boya Applied Paint	Elektrostatik Toz Boya Elektrostatic Powder Coating
Yükseklik Highness	67 cm	Ahşap Wood	1. Sınıf Emprenyeli Çam Impregnated Pine

EF-973



Genişlik Widness	100 cm	Malzeme Material	ST 37 Metal ST 37 Metal
Derinlik Deepness	48 cm	Uygulanan Boya Applied Paint	Elektrostatik Toz Boya Elektrostatic Powder Coating
Yükseklik Highness	67 cm	Ahşap Wood	1. Sınıf Emprenyeli Çam Impregnated Pine

EF-974



Genişlik Widness	133 cm	Malzeme Material	ST 37 Metal ST 37 Metal
Derinlik Deepness	48 cm	Uygulanan Boya Applied Paint	Elektrostatik Toz Boya Elektrostatic Powder Coating
Yükseklik Highness	67 cm	Ahşap Wood	1. Sınıf Emprenyeli Çam Impregnated Pine



EF-975



Genişlik Widness	64 cm	Malzeme Material	Paslanmaz Çelik Stainless Steel
Derinlik Deepness	32 cm	Uygulanan Boya Applied Paint	
Yükseklik Highness	72 cm	Ahşap Wood	

EF-976



Genişlik Widness	96 cm	Malzeme Material	Paslanmaz Çelik Stainless Steel
Derinlik Deepness	32 cm	Uygulanan Boya Applied Paint	
Yükseklik Highness	72 cm	Ahşap Wood	

EF-977



Genişlik Widness	128 cm	Malzeme Material	Paslanmaz Çelik Stainless Steel
Derinlik Deepness	32 cm	Uygulanan Boya Applied Paint	
Yükseklik Highness	72 cm	Ahşap Wood	

EF-978



Genişlik Widness	64 cm	Malzeme Material	Paslanmaz Çelik Stainless Steel
Derinlik Deepness	32 cm	Uygulanan Boya Applied Paint	
Yükseklik Highness	65 cm	Ahşap Wood	

EF-979



Genişlik Widness	96 cm	Malzeme Material	Paslanmaz Çelik Stainless Steel
Derinlik Deepness	32 cm	Uygulanan Boya Applied Paint	
Yükseklik Highness	65 cm	Ahşap Wood	

EF-980



Genişlik Widness	128 cm	Malzeme Material	Paslanmaz Çelik Stainless Steel
Derinlik Deepness	32 cm	Uygulanan Boya Applied Paint	
Yükseklik Highness	65 cm	Ahşap Wood	



GERİ DÖNÜŞÜM KUTULARI

RECYCLING BINS

EF-981



Genişlik Widness	64 cm	Malzeme Material	Paslanmaz Çelik Stainless Steel
Derinlik Deepness	32 cm	Uygulanan Boya Applied Paint	
Yükseklik Highness	65 cm	Ahşap Wood	

EF-982



Genişlik Widness	96 cm	Malzeme Material	Paslanmaz Çelik Stainless Steel
Derinlik Deepness	32 cm	Uygulanan Boya Applied Paint	
Yükseklik Highness	65 cm	Ahşap Wood	

EF-983



Genişlik Widness	128 cm	Malzeme Material	Paslanmaz Çelik Stainless Steel
Derinlik Deepness	32 cm	Uygulanan Boya Applied Paint	
Yükseklik Highness	65 cm	Ahşap Wood	

EF-984



Genişlik Widness	64 cm	Malzeme Material	ST 37 Metal ST 37 Metal
Derinlik Deepness	32 cm	Uygulanan Boya Applied Paint	Elektrostatik Toz Boya Elektrostatic Powder Coating
Yükseklik Highness	65 cm	Ahşap Wood	

EF-985



Genişlik Widness	96 cm	Malzeme Material	ST 37 Metal ST 37 Metal
Derinlik Deepness	32 cm	Uygulanan Boya Applied Paint	Elektrostatik Toz Boya Elektrostatic Powder Coating
Yükseklik Highness	65 cm	Ahşap Wood	

EF-986



Genişlik Widness	128 cm	Malzeme Material	ST 37 Metal ST 37 Metal
Derinlik Deepness	32 cm	Uygulanan Boya Applied Paint	Elektrostatik Toz Boya Elektrostatic Powder Coating
Yükseklik Highness	65 cm	Ahşap Wood	



EF-987



Genişlik Widness	52 cm	Malzeme Material	Paslanmaz Çelik Stainless Steel
Derinlik Deepness	27 cm	Uygulanan Boya Applied Paint	
Yükseklik Highness	77 cm	Ahşap Wood	

EF-988



Genişlik Widness	78 cm	Malzeme Material	Paslanmaz Çelik Stainless Steel
Derinlik Deepness	27 cm	Uygulanan Boya Applied Paint	
Yükseklik Highness	77 cm	Ahşap Wood	

EF-989



Genişlik Widness	104 cm	Malzeme Material	Paslanmaz Çelik Stainless Steel
Derinlik Deepness	27 cm	Uygulanan Boya Applied Paint	
Yükseklik Highness	77 cm	Ahşap Wood	

EF-990



Genişlik Widness	52 cm	Malzeme Material	ST 37 Metal ST 37 Metal
Derinlik Deepness	27 cm	Uygulanan Boya Applied Paint	Elektrostatik Toz Boya Elektrostatic Powder Coating
Yükseklik Highness	77 cm	Ahşap Wood	

EF-991



Genişlik Widness	78 cm	Malzeme Material	ST 37 Metal ST 37 Metal
Derinlik Deepness	27 cm	Uygulanan Boya Applied Paint	Elektrostatik Toz Boya Elektrostatic Powder Coating
Yükseklik Highness	77 cm	Ahşap Wood	

EF-992



Genişlik Widness	104 cm	Malzeme Material	ST 37 Metal ST 37 Metal
Derinlik Deepness	27 cm	Uygulanan Boya Applied Paint	Elektrostatik Toz Boya Elektrostatic Powder Coating
Yükseklik Highness	77 cm	Ahşap Wood	



GERİ DÖNÜŞÜM KUTULARI

RECYCLING BINS

EF-993



Genişlik Widness	64 cm	Malzeme Material	Paslanmaz Çelik Stainless Steel
Derinlik Deepness	32 cm	Uygulanan Boya Applied Paint	
Yükseklik Highness	60 cm	Ahşap Wood	

EF-994



Genişlik Widness	96 cm	Malzeme Material	Paslanmaz Çelik Stainless Steel
Derinlik Deepness	32 cm	Uygulanan Boya Applied Paint	
Yükseklik Highness	60 cm	Ahşap Wood	

EF-995



Genişlik Widness	120 cm	Malzeme Material	ST 37 Metal ST 37 Metal
Derinlik Deepness	32 cm	Uygulanan Boya Applied Paint	Elektrostatik Toz Boya Elektrostatic Powder Coating
Yükseklik Highness	72 cm	Ahşap Wood	

EF-996



Genişlik Widness	120 cm	Malzeme Material	Paslanmaz Çelik Stainless Steel
Derinlik Deepness	32 cm	Uygulanan Boya Applied Paint	
Yükseklik Highness	72 cm	Ahşap Wood	

EF-997



Genişlik Widness	128 cm	Malzeme Material	ST 37 Metal ST 37 Metal
Derinlik Deepness	32 cm	Uygulanan Boya Applied Paint	Elektrostatik Toz Boya Elektrostatic Powder Coating
Yükseklik Highness	72 cm	Ahşap Wood	

EF-998



Genişlik Widness	128 cm	Malzeme Material	Paslanmaz Çelik Stainless Steel
Derinlik Deepness	32 cm	Uygulanan Boya Applied Paint	
Yükseklik Highness	72 cm	Ahşap Wood	



EF-999



Genişlik Widness	43 cm	Malzeme Material	Paslanmaz Çelik Stainless Steel
Derinlik Deepness	33 cm	Uygulanan Boya Applied Paint	
Yükseklik Highness	80 cm	Ahşap Wood	

EF-1000



Genişlik Widness	63 cm	Malzeme Material	Paslanmaz Çelik Stainless Steel
Derinlik Deepness	33 cm	Uygulanan Boya Applied Paint	
Yükseklik Highness	80 cm	Ahşap Wood	

EF-1001



Genişlik Widness	94 cm	Malzeme Material	Paslanmaz Çelik Stainless Steel
Derinlik Deepness	33 cm	Uygulanan Boya Applied Paint	
Yükseklik Highness	80 cm	Ahşap Wood	

EF-1002



Genişlik Widness	124 cm	Malzeme Material	Paslanmaz Çelik Stainless Steel
Derinlik Deepness	33 cm	Uygulanan Boya Applied Paint	
Yükseklik Highness	80 cm	Ahşap Wood	

EF-1003



Genişlik Widness	63 cm	Malzeme Material	Paslanmaz Çelik Stainless Steel
Derinlik Deepness	33 cm	Uygulanan Boya Applied Paint	
Yükseklik Highness	80 cm	Ahşap Wood	

EF-1004



Genişlik Widness	94 cm	Malzeme Material	Paslanmaz Çelik Stainless Steel
Derinlik Deepness	33 cm	Uygulanan Boya Applied Paint	
Yükseklik Highness	80 cm	Ahşap Wood	





ROOFED PICNIC TABLES
GAZEBOS
PICNIC TABLES

ÇATILI PİKNIK MASALARI
GAZEBOLAR
PİKNIK MASALARI



www.gamainsaat.com

ROOFED PICNIC TABLES

ÇATILI PİKNIK MASALARI

EF-1051



Genişlik Widness	240 cm	Malzeme Material	ST 37 Metal ST 37 Metal
Derinlik Deepness	252 cm	Uygulanan Boya Applied Paint	Elektrostatik Toz Boya Elektrostatic Powder Coating
Yükseklik Highness	239 cm	Ahşap Wood	1. Sınıf Emprenyeli Çam Impregnated Pine

EF-1052



Genişlik Widness	240 cm	Malzeme Material	ST 37 Metal ST 37 Metal
Derinlik Deepness	259 cm	Uygulanan Boya Applied Paint	Elektrostatik Toz Boya Elektrostatic Powder Coating
Yükseklik Highness	269 cm	Ahşap Wood	1. Sınıf Emprenyeli Çam Impregnated Pine

EF-1053



Genişlik Widness	200 cm	Malzeme Material	ST 37 Metal ST 37 Metal
Derinlik Deepness	249 cm	Uygulanan Boya Applied Paint	Elektrostatik Toz Boya Elektrostatic Powder Coating
Yükseklik Highness	250 cm	Ahşap Wood	1. Sınıf Emprenyeli Çam Impregnated Pine

EF-1054



Genişlik Widness	249 cm	Malzeme Material	ST 37 Metal ST 37 Metal
Derinlik Deepness	368 cm	Uygulanan Boya Applied Paint	Elektrostatik Toz Boya Elektrostatic Powder Coating
Yükseklik Highness	280 cm	Ahşap Wood	1. Sınıf Emprenyeli Çam Impregnated Pine



EF-1055



Genişlik Widness	185 cm	Malzeme Material	ST 37 Metal ST 37 Metal
Derinlik Deepness	192 cm	Uygulanan Boya Applied Paint	Elektrostatik Toz Boya Elektrostatic Powder Coating
Yükseklik Highness	218 cm	Ahşap Wood	1. Sınıf Emprenyeli Çam Impregnated Pine

EF-1056



Genişlik Widness	300 cm	Malzeme Material	ST 37 Metal ST 37 Metal
Derinlik Deepness	300 cm	Uygulanan Boya Applied Paint	Elektrostatik Toz Boya Elektrostatic Powder Coating
Yükseklik Highness	320 cm	Ahşap Wood	1. Sınıf Emprenyeli Çam Impregnated Pine

EF-1057



Genişlik Widness	300 cm	Malzeme Material	ST 37 Metal ST 37 Metal
Derinlik Deepness	300 cm	Uygulanan Boya Applied Paint	Elektrostatik Toz Boya Elektrostatic Powder Coating
Yükseklik Highness	320 cm	Ahşap Wood	1. Sınıf Emprenyeli Çam Impregnated Pine

EF-1058



Genişlik Widness	400 cm	Malzeme Material	ST 37 Metal ST 37 Metal
Derinlik Deepness	400 cm	Uygulanan Boya Applied Paint	Elektrostatik Toz Boya Elektrostatic Powder Coating
Yükseklik Highness	320 cm	Ahşap Wood	1. Sınıf Emprenyeli Çam Impregnated Pine



ROOFED PICNIC TABLES AND GAZEBOS

ÇATILI PİKNIK MASALARI VE GAZEBOLAR

EF-1059



Genişlik Widness	249 cm	Malzeme Material	
Derinlik Deepness	361 cm	Uygulanan Boya Applied Paint	
Yükseklik Highness	278 cm	Ahşap Wood	1. Sınıf Emprenyeli Çam Impregnated Pine

EF-1060



Genişlik Widness	300 cm	Malzeme Material	
Derinlik Deepness	300 cm	Uygulanan Boya Applied Paint	
Yükseklik Highness	320 cm	Ahşap Wood	1. Sınıf Emprenyeli Çam Impregnated Pine

EF-1061



Genişlik Widness	400 cm	Malzeme Material	
Derinlik Deepness	400 cm	Uygulanan Boya Applied Paint	
Yükseklik Highness	320 cm	Ahşap Wood	1. Sınıf Emprenyeli Çam Impregnated Pine

EF-1062



Genişlik Widness	400 cm	Malzeme Material	
Derinlik Deepness	400 cm	Uygulanan Boya Applied Paint	
Yükseklik Highness	320 cm	Ahşap Wood	1. Sınıf Emprenyeli Çam Impregnated Pine



PERGOLALAR

PERGOLAS

EF-1063



Genişlik Widness	550 cm	Malzeme Material	
Derinlik Deepness	550 cm	Uygulanan Boya Applied Paint	
Yükseklik Highness	300 cm	Ahşap Wood	1. Sınıf Emprenyeli Çam Impregnated Pine

EF-1064



Genişlik Widness	500 cm	Malzeme Material	
Derinlik Deepness	500 cm	Uygulanan Boya Applied Paint	
Yükseklik Highness	280 cm	Ahşap Wood	1. Sınıf Emprenyeli Çam Impregnated Pine

EF-1065



Genişlik Widness	240 cm	Malzeme Material	
Derinlik Deepness	500 cm	Uygulanan Boya Applied Paint	
Yükseklik Highness	260 cm	Ahşap Wood	1. Sınıf Emprenyeli Çam Impregnated Pine

EF-1066



Genişlik Widness	240 cm	Malzeme Material	ST 37 Metal ST 37 Metal
Derinlik Deepness	300 cm	Uygulanan Boya Applied Paint	Elektrostatik Toz Boya Elektrostatic Powder Coating
Yükseklik Highness	250 cm	Ahşap Wood	1. Sınıf Emprenyeli Çam Impregnated Pine



EF-1101



Genişlik Widness	220 cm	Malzeme Material	ST 37 Metal ST 37 Metal
Derinlik Deepness	220 cm	Uygulanan Boya Applied Paint	Elektrostatik Toz Boya Elektrostatic Powder Coating
Yükseklik Highness	70 cm	Ahşap Wood	1. Sınıf Emprenyeli Çam Impregnated Pine

EF-1102



Genişlik Widness	190 cm	Malzeme Material	ST 37 Metal ST 37 Metal
Derinlik Deepness	190 cm	Uygulanan Boya Applied Paint	Elektrostatik Toz Boya Elektrostatic Powder Coating
Yükseklik Highness	70 cm	Ahşap Wood	1. Sınıf Emprenyeli Çam Impregnated Pine

EF-1103



Genişlik Widness	175 cm	Malzeme Material	ST 37 Metal ST 37 Metal
Derinlik Deepness	145 cm	Uygulanan Boya Applied Paint	Elektrostatik Toz Boya Elektrostatic Powder Coating
Yükseklik Highness	70 cm	Ahşap Wood	1. Sınıf Emprenyeli Çam Impregnated Pine



PİKNİK MASALARI

PICNIC TABLES

EF-1104



Genişlik Widness	165 cm	Malzeme Material	ST 37 Metal ST 37 Metal
Derinlik Deepness	150 cm	Uygulanan Boya Applied Paint	Elektrostatik Toz Boya Elektrostatic Powder Coating
Yükseklik Highness	70 cm	Ahşap Wood	1. Sınıf Emprenyeli Çam Impregnated Pine

EF-1105



Genişlik Widness	170 cm	Malzeme Material	ST 37 Metal ST 37 Metal
Derinlik Deepness	150 cm	Uygulanan Boya Applied Paint	Elektrostatik Toz Boya Elektrostatic Powder Coating
Yükseklik Highness	70 cm	Ahşap Wood	1. Sınıf Emprenyeli Çam Impregnated Pine

EF-1106



Genişlik Widness	160 cm	Malzeme Material	ST 37 Metal ST 37 Metal
Derinlik Deepness	150 cm	Uygulanan Boya Applied Paint	Elektrostatik Toz Boya Elektrostatic Powder Coating
Yükseklik Highness	70 cm	Ahşap Wood	1. Sınıf Emprenyeli Çam Impregnated Pine



PICNIC TABLES

PİKNİK MASALARI

EF-1107



Genişlik Widness	180 cm	Malzeme Material	ST 37 Metal ST 37 Metal
Derinlik Deepness	145 cm	Uygulanan Boya Applied Paint	Elektrostatik Toz Boya Elektrostatic Powder Coating
Yükseklik Highness	70 cm	Ahşap Wood	1. Sınıf Emprenyeli Çam Impregnated Pine

EF-1108



Genişlik Widness	160 cm	Malzeme Material	ST 37 Metal ST 37 Metal
Derinlik Deepness	145 cm	Uygulanan Boya Applied Paint	Elektrostatik Toz Boya Elektrostatic Powder Coating
Yükseklik Highness	70 cm	Ahşap Wood	1. Sınıf Emprenyeli Çam Impregnated Pine

EF-1109



Genişlik Widness	172 cm	Malzeme Material	
Derinlik Deepness	145 cm	Uygulanan Boya Applied Paint	
Yükseklik Highness	70 cm	Ahşap Wood	1. Sınıf Emprenyeli Çam Impregnated Pine

EF-1110



Genişlik Widness	172 cm	Malzeme Material	
Derinlik Deepness	145 cm	Uygulanan Boya Applied Paint	
Yükseklik Highness	70 cm	Ahşap Wood	1. Sınıf Emprenyeli Çam Impregnated Pine





***SPORTS EQUIPMENT
AND
FLOOR COVERINGS***

***SPOR EKİPMANLARI
VE
ZEMİN KAPLAMALARI***



www.gamainsaat.com

SPOR EKİPMANLARI

SPORTS EQUIPMENT

EF-1201



EF-1202



EF-1203



EF-1204



EF-1205



EF-1206



FLOOR COVERINGS

ZEMİN KAPLAMALARI

EPDM ZEMİN KAPLAMALARI
EPDM FLOOR COVERINGS



KARO KAÇUK ZEMİN KAPLAMALARI
RUBBER FLOOR COVERINGS



AKRİLİK ZEMİN KAPLAMALARI
ACRYLIC FLOOR COVERINGS



SENTETİK ÇİM ZEMİN KAPLAMALARI
SYNTHETIC GRASS COVERING













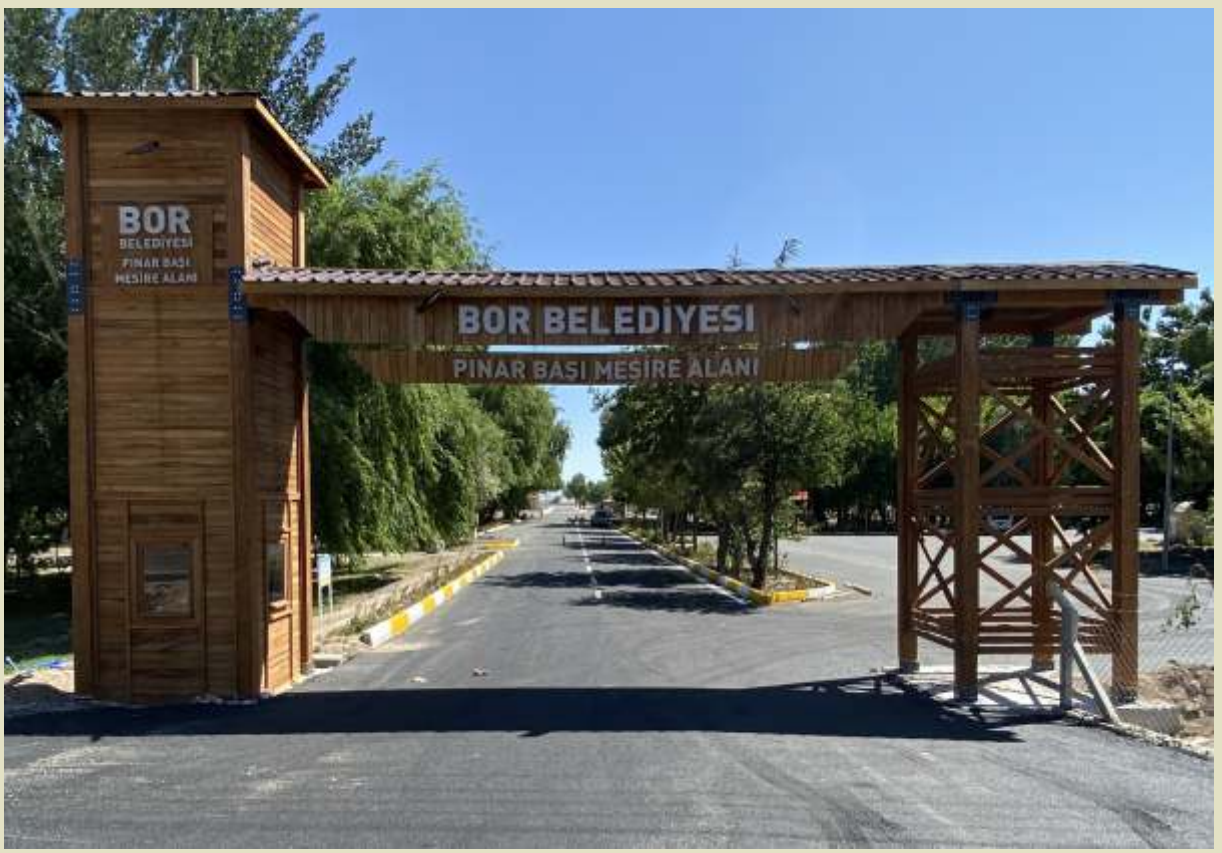













GAMA
PEYZAJ İNŞAAT
MİMARLIK VE MÜHENDİSLİK
TİCARET LİMİTED ŞİRKETİ



-  Saray Mah. 1 Cad. No: 71
Kahramankazan/Ankara
-  +90 507 398 75 14 +90 505 766 77 12
-  +90 507 398 75 14 +90 505 766 77 12
-  info@gamainsaat.com
-  /infogamainsaat
-  /infogamainsaat
-  www.gamainsaat.com

Siz hayal edin biz üretelim

You imagine
We produce



www.gamainsaat.com